

Setting Up Your Workstation To Fit You!

1. **Chair.** Office chairs are designed to provide seated support for employees working at the computer workstation. A good chair can provide comfort and support for the body. A properly adjusted chair can reduce fatigue by supporting the back, legs, and arms.

✓ **Adjust Properly** –

- **Height:** Correct chair height is when your feet are resting flat on the floor or a footrest, and the back of the knee is slightly higher than the seat of the chair. This will allow the blood in the legs to circulate freely.
- **Backrest:** The backrest should support the entire back comfortably. The rounded, curved section of the backrest should be adjusted to support your waistline or “belt” line. The backrest should be close enough to support your back during all desk activities.
- **Armrests (Optional):** The armrests should be adjusted high enough so the forearms rest lightly on them. If they are too low, you will find yourself slouching or leaning to one side in order to reach them. If they are too high, you will find yourself working with your shoulders elevated.

2. **Keyboard.** Keyboards either sit on top of the desk surface or on a pull-out keyboard platform. A good rule of thumb to remember when working at the keyboard is to keep your elbows level with the spacebar of the keyboard, with the elbows resting comfortably at your side. This allows you to work with your wrists in a straight, neutral position and your shoulders relaxed.

✓ **Adjust Properly** –

- **Keyboard:** Make sure the keyboard legs are flat. Keyboards should be flat on the desktop or pull-out keyboard tray or angled negatively with the back side slightly lower than the front.
- **Wrist rest:** This provides a soft place to rest on and helps to keep the wrists straight. **Remember to use only during pauses from keying.**

3. **Mouse.** Most computers have a mouse. Overuse of the mouse can cause fatigue. Remember that keyboard commands are a very effective alternative for excessive mouse usage.

✓ **Use Properly** –

- Ensure that the mouse is properly placed close to the body.
- Don't over-grip the mouse. Use a relaxed hold.
- When using the mouse, don't just move the wrist! Move the entire arm to move the mouse around.
- Program the mouse to help with common functions.
- Use pull-down menus and keyboard commands to reduce mouse usage.

4. **Monitor.** Monitors are usually placed where space allows. Many people shove their monitors into a corner so they can have increased desk space. This can create problems.

✓ **Adjust Properly** –

- **Location:** The monitor should be placed *directly in front of you!* Posture follows vision. If the monitor is in the corner, you will twist your neck and head to view the monitor. This is not a good posture to hold eight hours a day.
- **Distance:** The monitor should be at the correct viewing distance. Generally, it should be placed out 18 to 24 inches, or about an arm's distance away. If you find yourself leaning forward to read the monitor, it is too far away. Pull it closer.
- **Height:** For normal vision, typically the top of the monitor screen should be AT eye level. The top of the monitor screen should never be above eye level. If it is, it forces you to look up and places the neck into an awkward position. If your monitor is flat on the desktop and angled up, it may be too low, which pulls your posture forward. With the monitor angled up, it can catch too much glare which can create eyestrain.

NOTE: Bifocal users may have trouble if the monitor is too high as they will tilt their head back and lift their chin up to view the screen through the bottom portion of the glasses. One recommendation for bifocal users is to lower the monitor flat onto the desktop and angle it down a bit until it is easily read through the bottom portion of the glasses.

- **Glare:** Place the computer set up perpendicular to the window. Shield outside sources of light with blinds, curtains, or window tinting.

✓ **Article Link:** http://www.osha.gov/SLTC/computerworkstations_ecat/index.html

Workspace ergonomics

- Always maintain a neutral position
- Items on your workstation should be placed within a reasonable parameter of your workspace

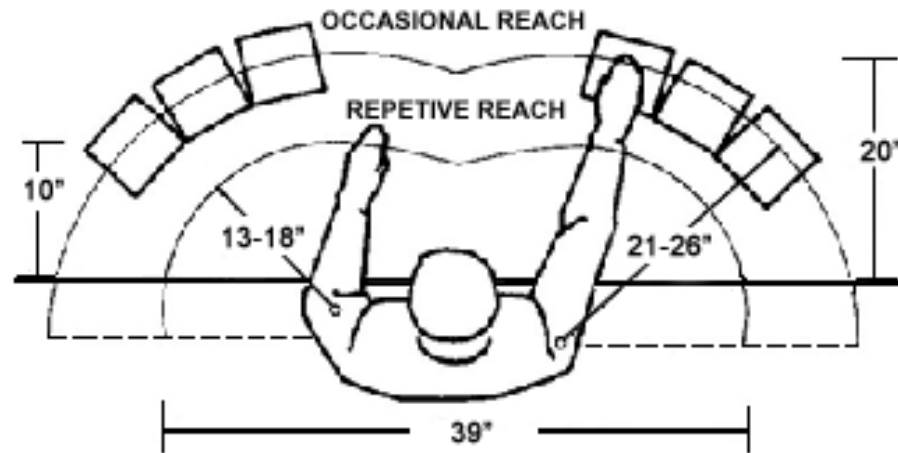

Office Ergonomics - workstation

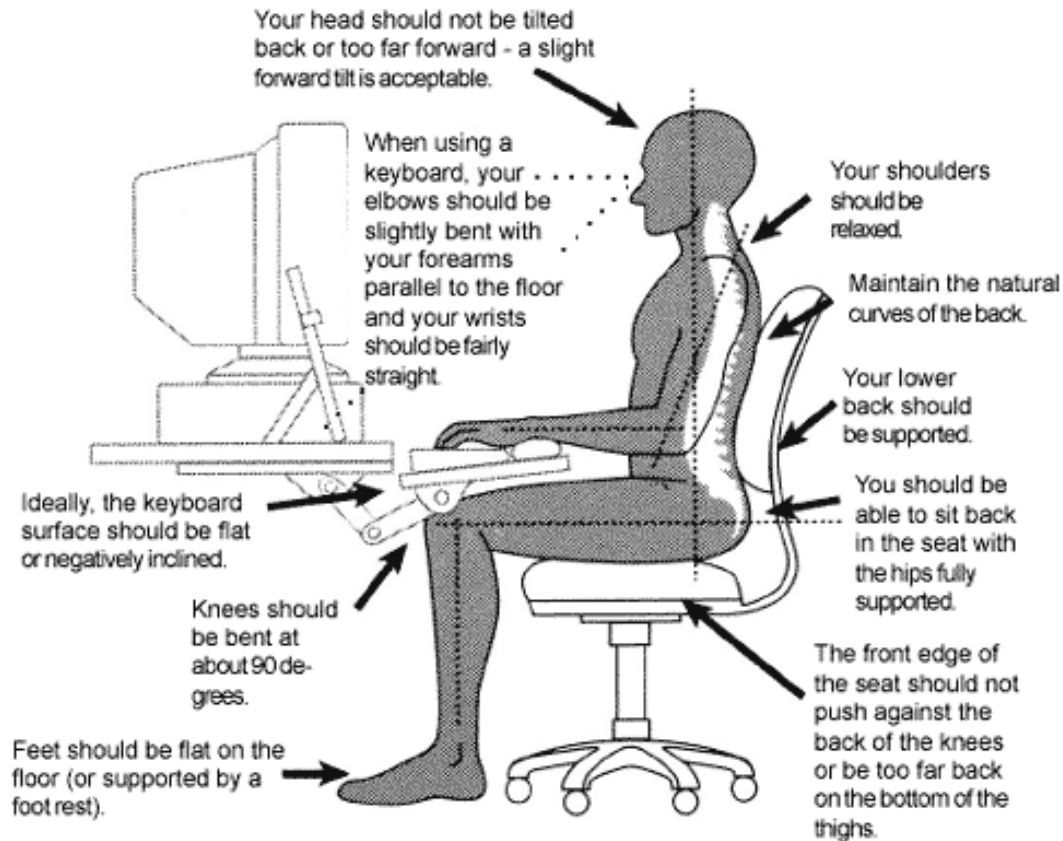

Office ergonomics – standing workstation

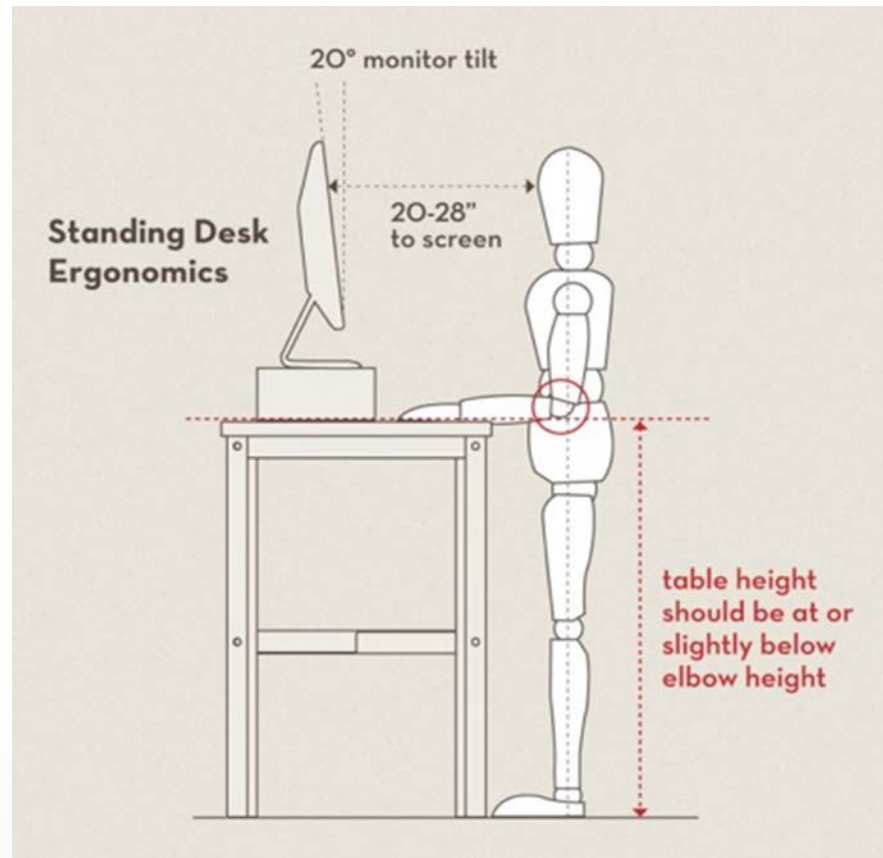

Office ergonomics - keyboard

RIGHT!



RIGHT!

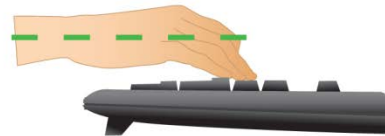

WRONG!

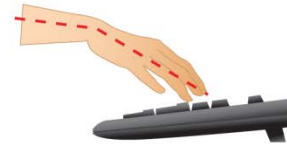

WRONG!



Office ergonomics - mouse



INCORRECT

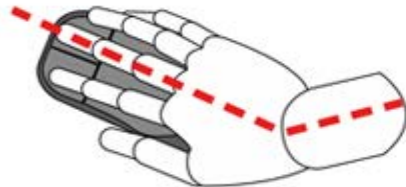
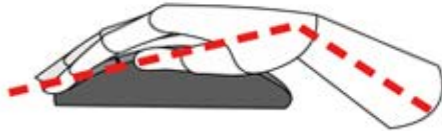

INCORRECT

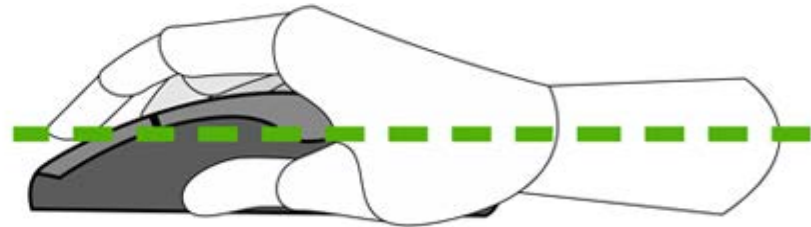
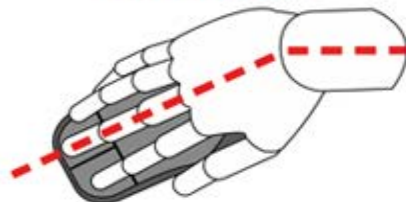

CORRECT

